

YOUR Crafts **BEAUTIFUL** Templates AUGUST 2015

Find the template you require on the contents list below and just print out the page or pages you need from your print menu

PAGE 2 HANDMADE HOME

Appliqué and embroider Abigail Mill's beach hut artwork with these simple shapes
Page 59 in magazine

PAGE 3-4 HIT THE ROAD

Let little ones test drive our stitched toy car - we've got all the templates you need
Page 103 in magazine

PAGE 5 SAILING CLUB

Create a gorgeous nautical sampler from fabric with our boat illustration
Page 82 in magazine

PAGE 6 BERRY SWEET

Use Posca Pens to decorate ceramics and card with strawberry artwork
Page 62 in magazine

PAGE 7-8 GOODY TWO-SHOES

Make papercraft 3-D shoes and accompanying cards with our motifs
Page 52 in magazine

PAGE 9 DOLL'S QUILT

Sew a patchwork quilt for your little one's toys, then follow our cross-stitch chart to decorate
Page 76 in magazine

PAGE 10 BIT OF A YARN

We plait with polymer clay to create a unique accessories set - here you'll find a heart and flower to copy
Page 85 in magazine

PAGE 11-12 MAKE & SELL

Corinne Bradd has made a pocket organiser, perfect for a craft room
Page 80 in magazine

PAGE 13-14 COCKTAIL TIME

Have a girly night in with your friends thanks to this boozy set - the artwork is fab!
Page 44 in magazine

Handmade Home

Appliqué and embroider Abigail Mill's beach hut artwork with these simple shapes
Page 59 in magazine
1 A4 page

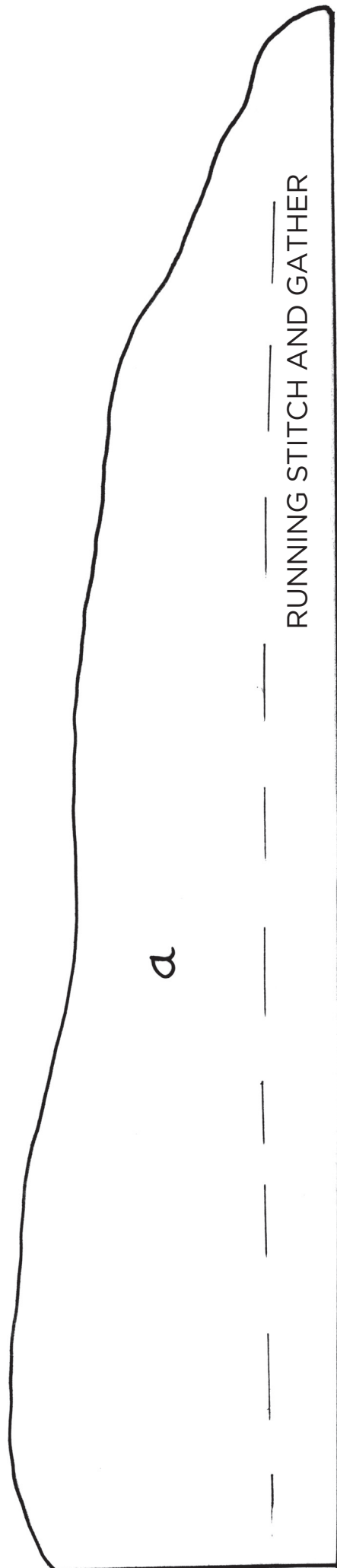
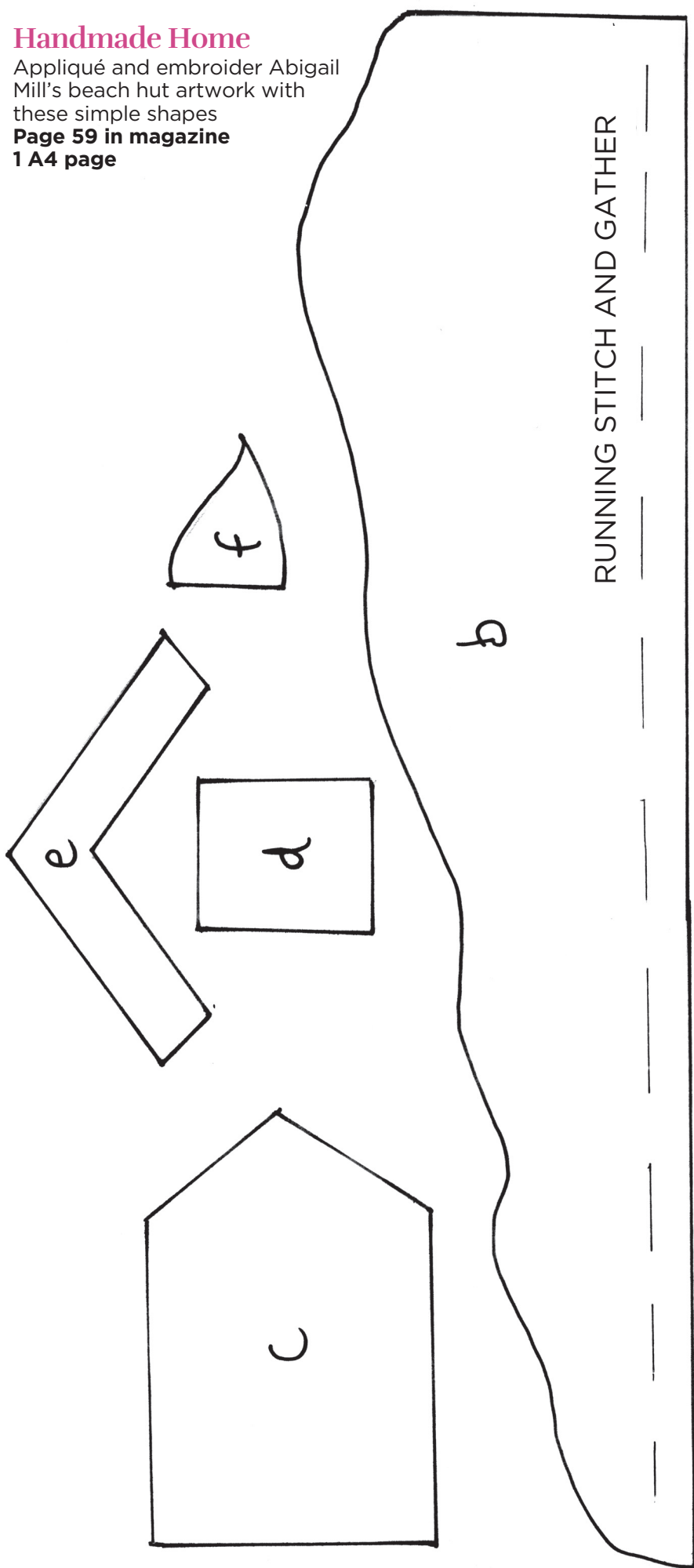

Hit The Road

Let little ones test drive our stitched toy car - we've got all the templates you need

Page 103 in magazine
2 A4 pages

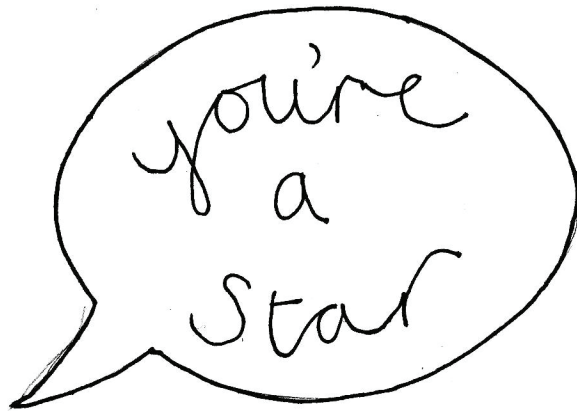

TAG

CARD

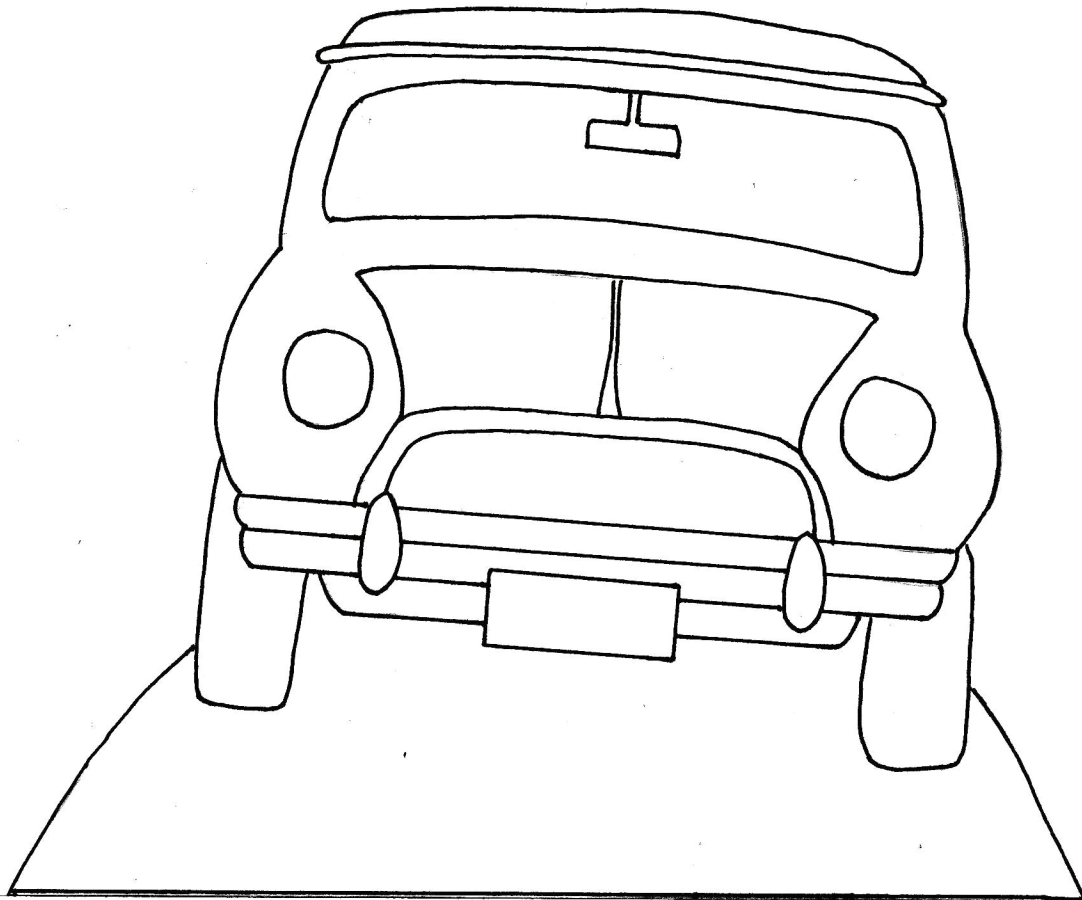

CAR SIDE

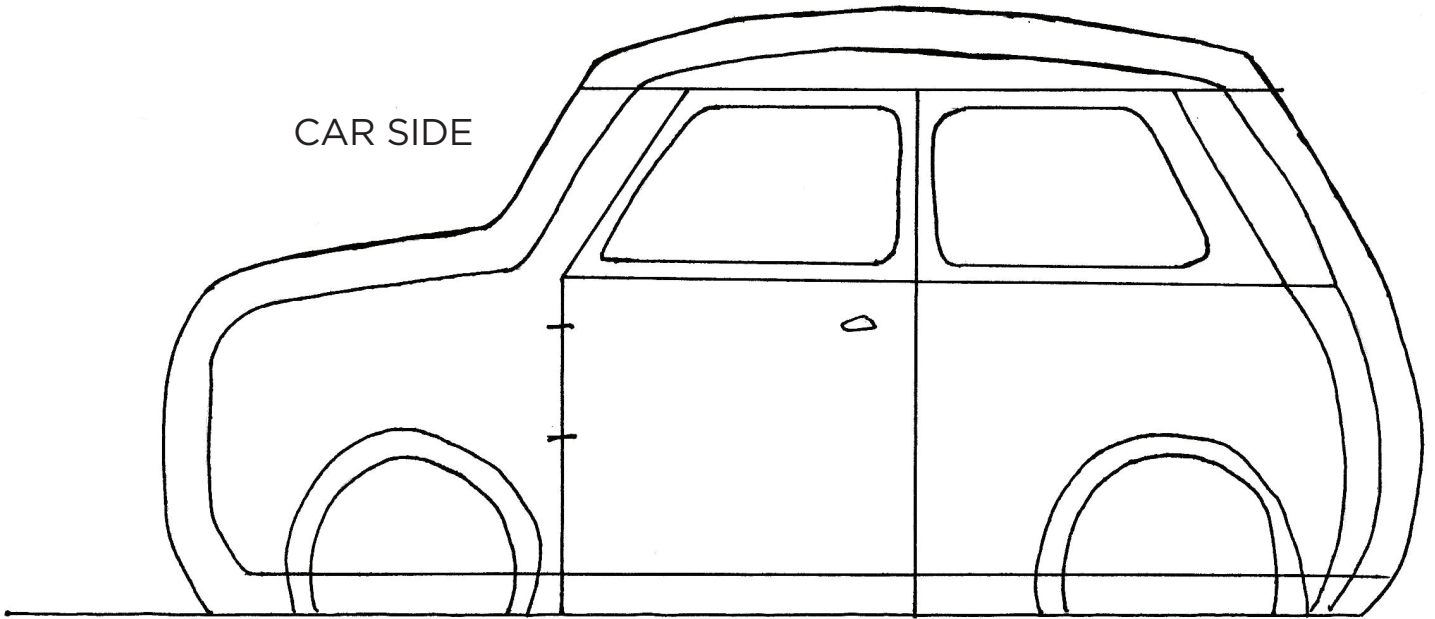

FRONT

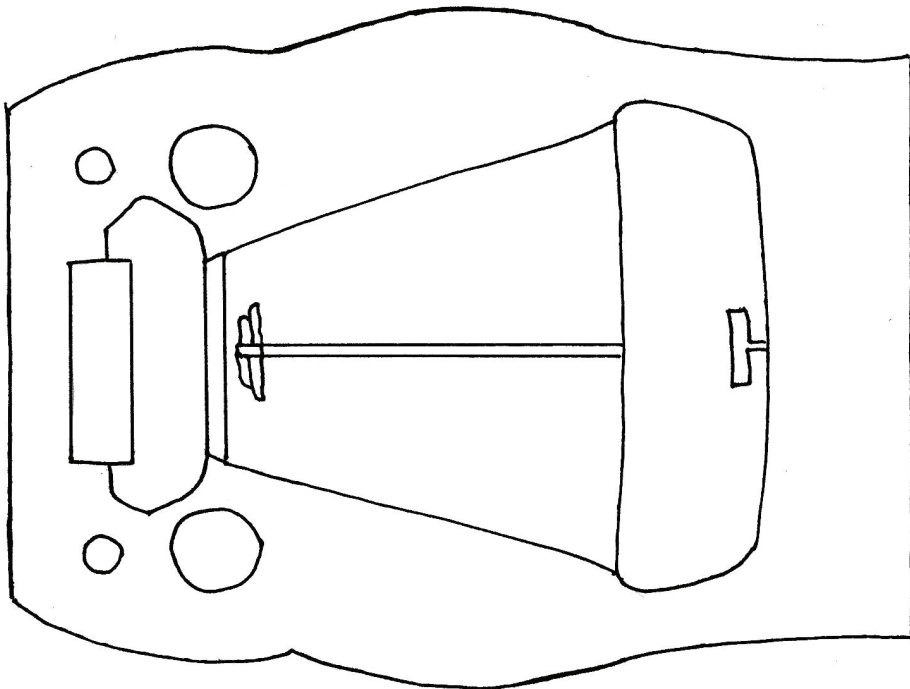

BACK

ROOF

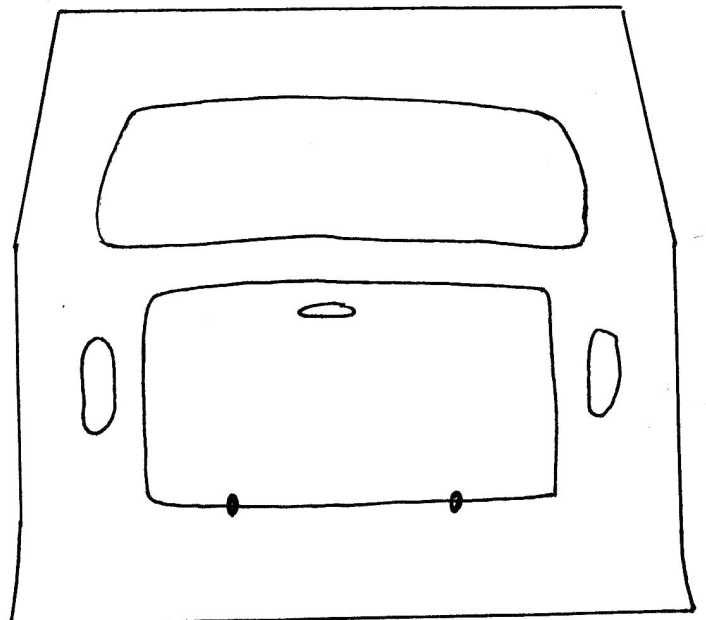
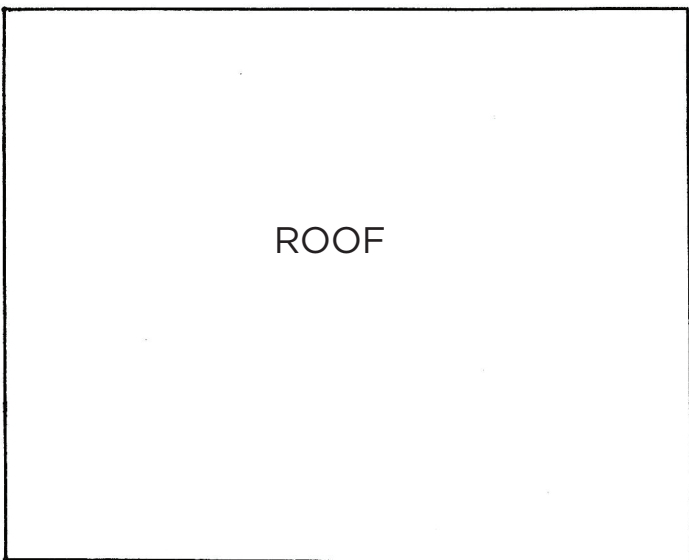

Sailing Club

Create a gorgeous nautical sampler from fabric with our boat illustration

Page 82 in magazine

1 A4 page

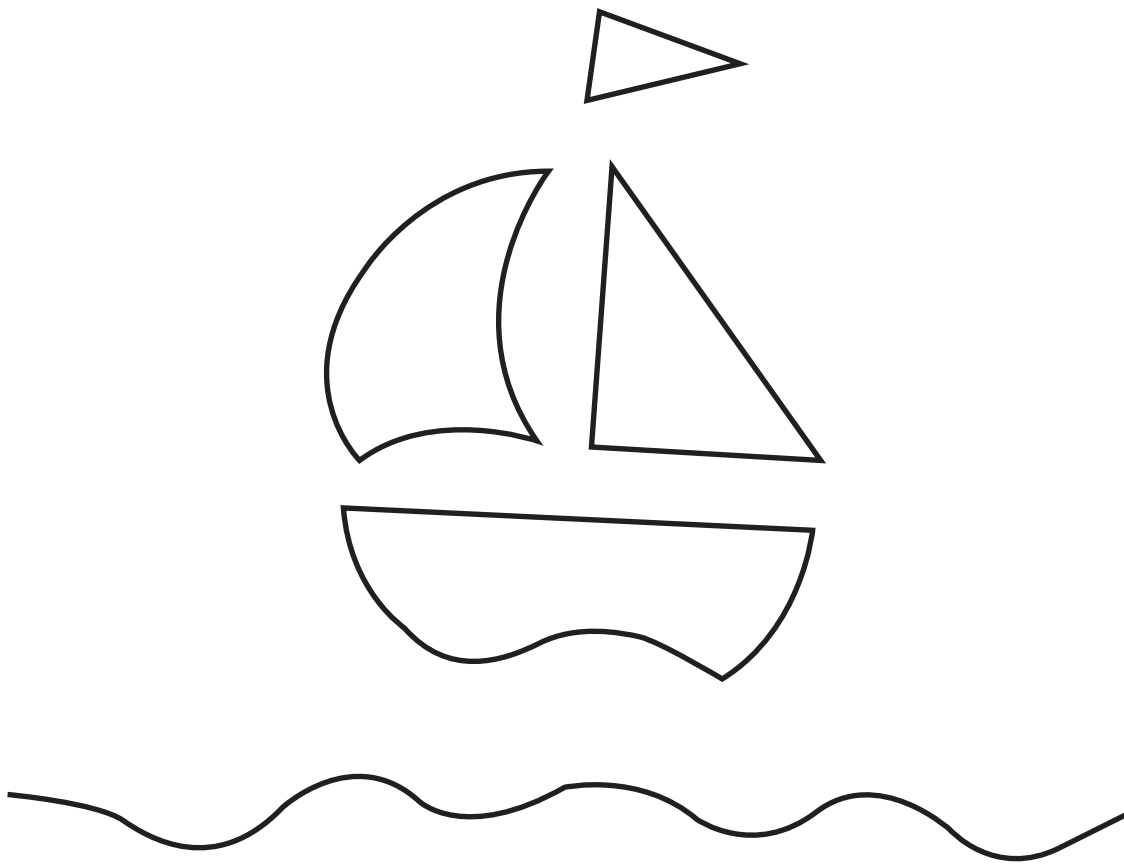

Berry Sweet

Use Posca Pens to decorate
ceramics and card with
strawberry artwork

Page 62 in magazine

1 A4 page

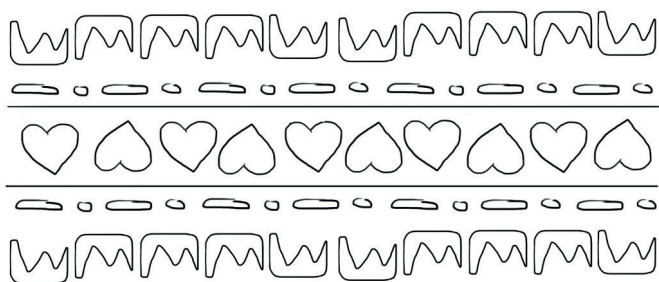

Goody Two-Shoes

Make papercraft 3-D shoes
and accompanying cards with
our motifs

Page 52 in magazine

2 A4 pages

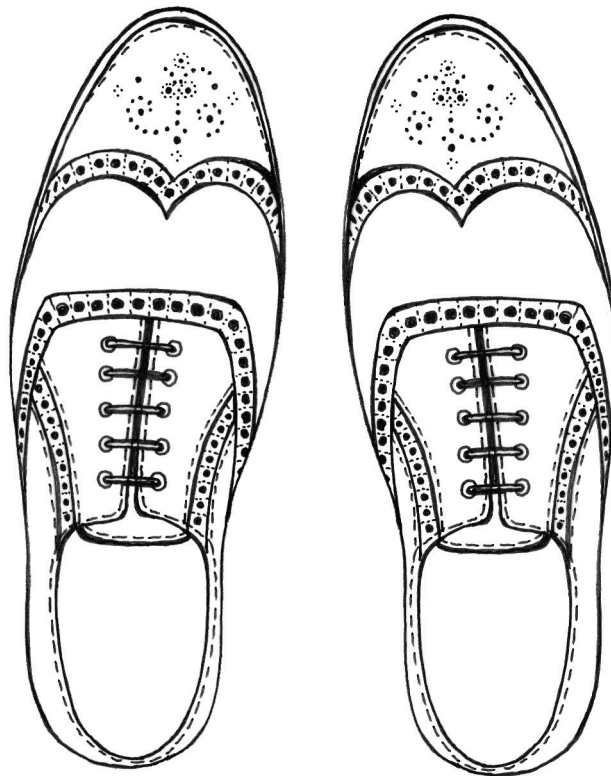

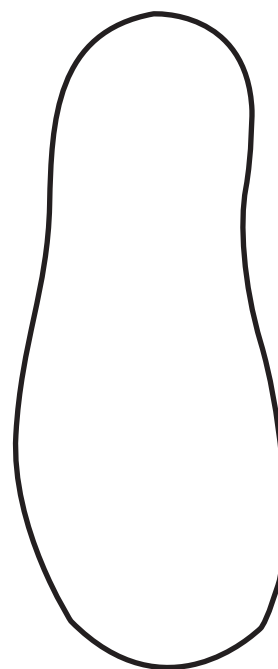
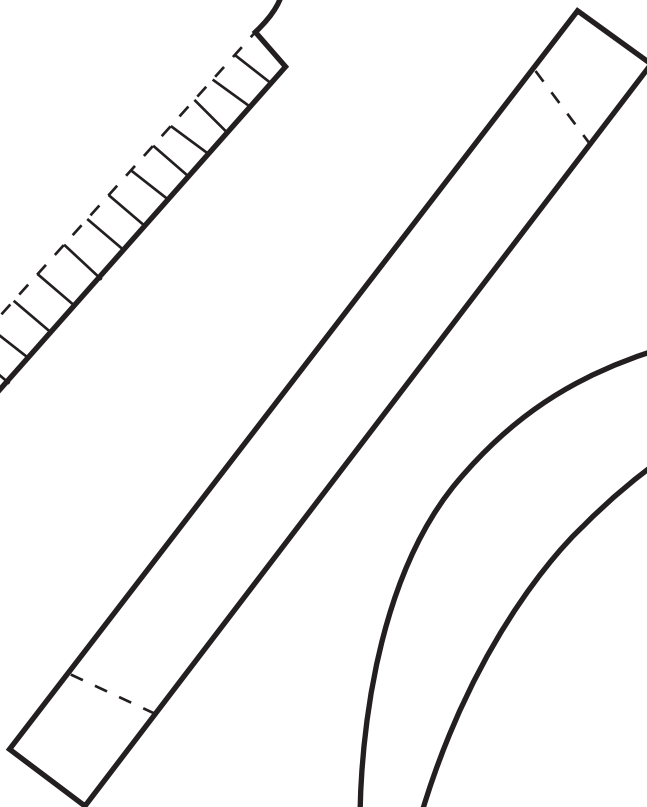
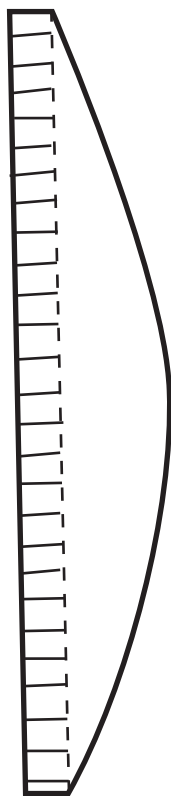
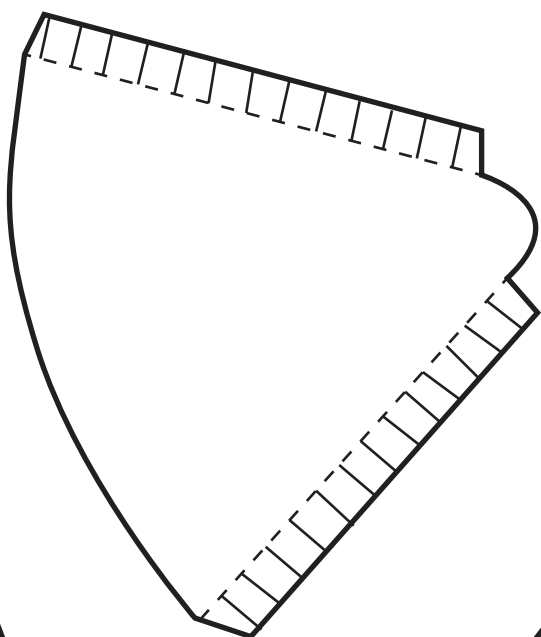
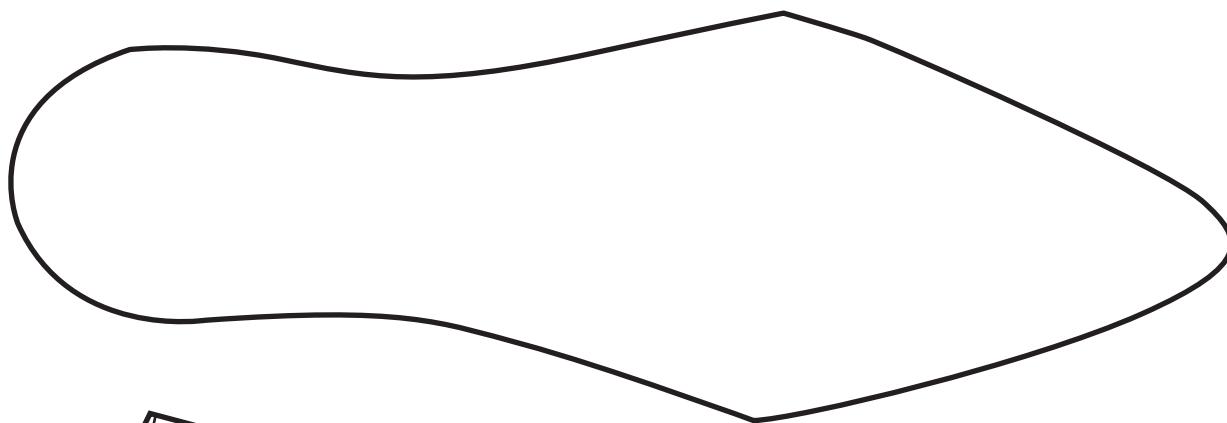

Doll's Quilt

Sew a patchwork quilt for your little one's toys, then follow our cross-stitch chart to decorate

Page 76 in magazine

1 A4 page

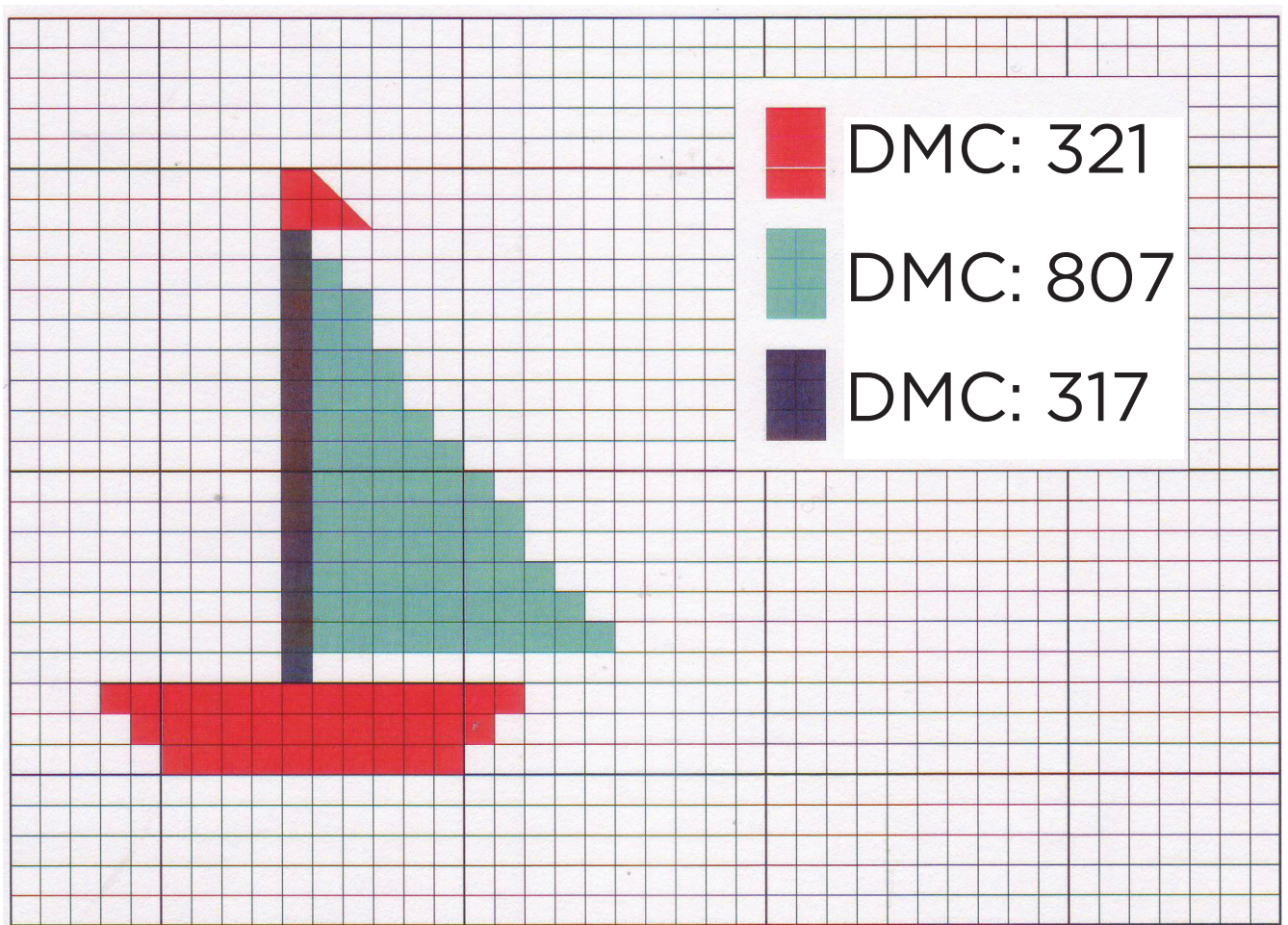

Bit Of A Yarn

We plait with polymer clay to create a unique accessories set - here you'll find a heart and flower to copy

Page 85 in magazine

1 A4 page

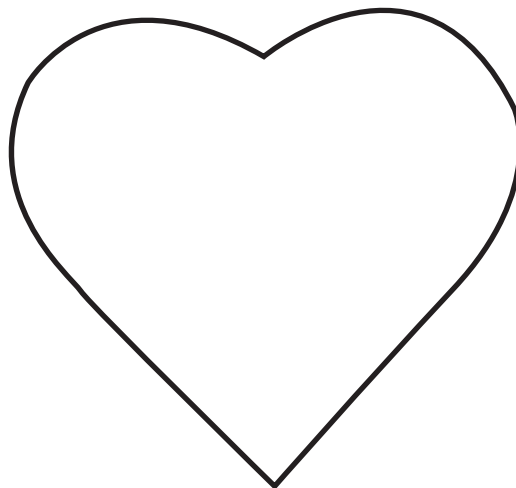
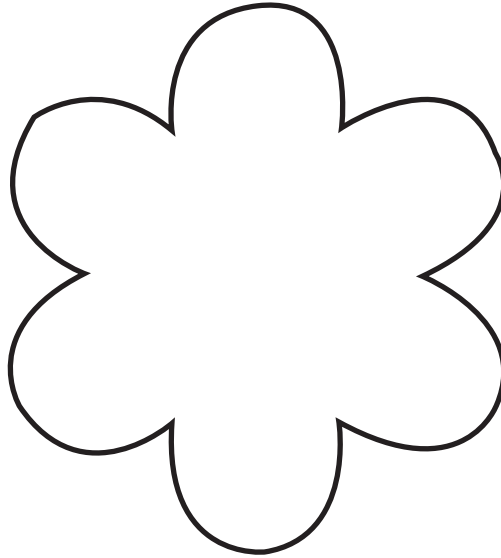

Make & Sell

Corinne Bradd has made a pocket organiser, perfect for a craft room

Page 80 in magazine

2 A4 pages

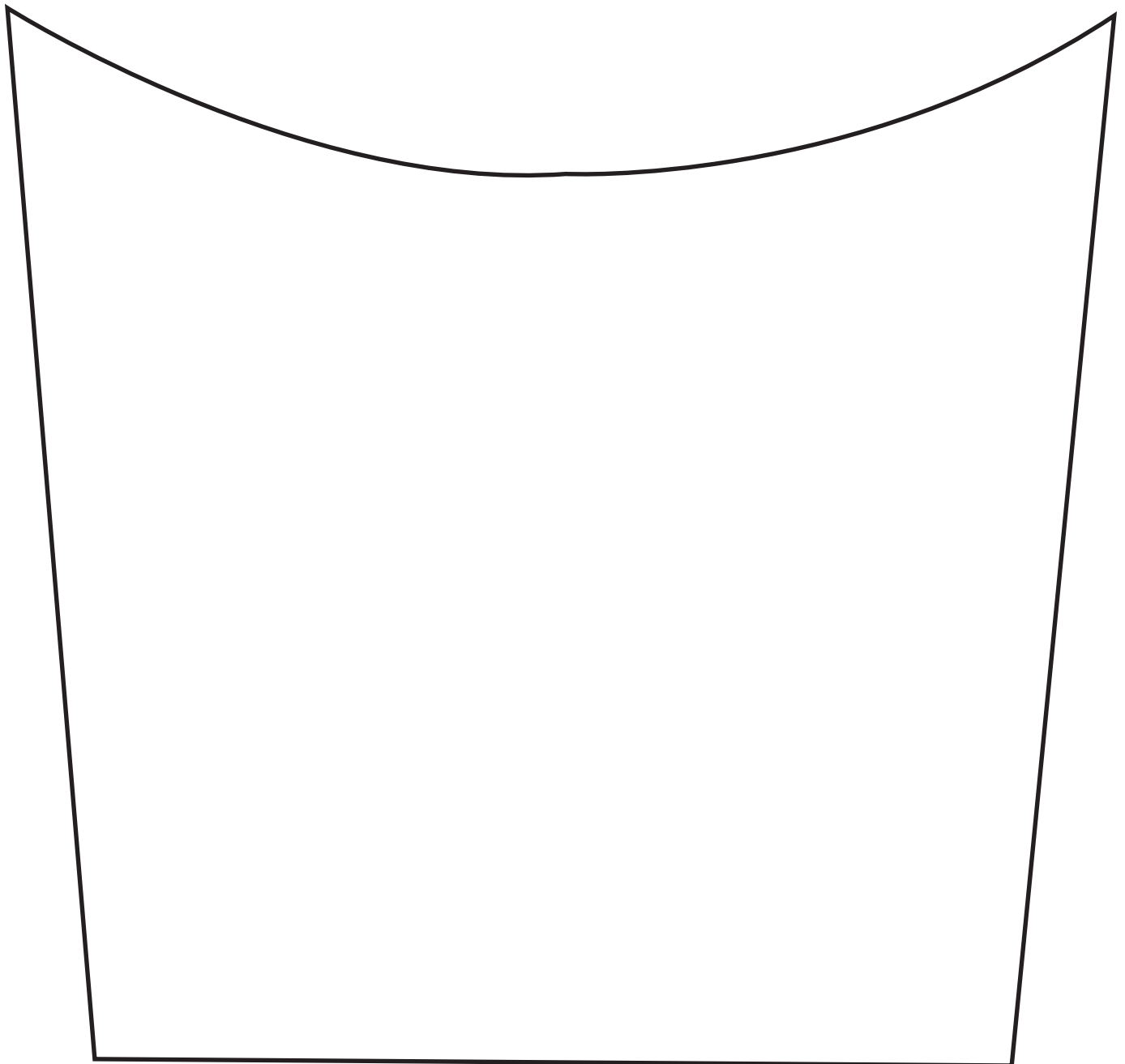

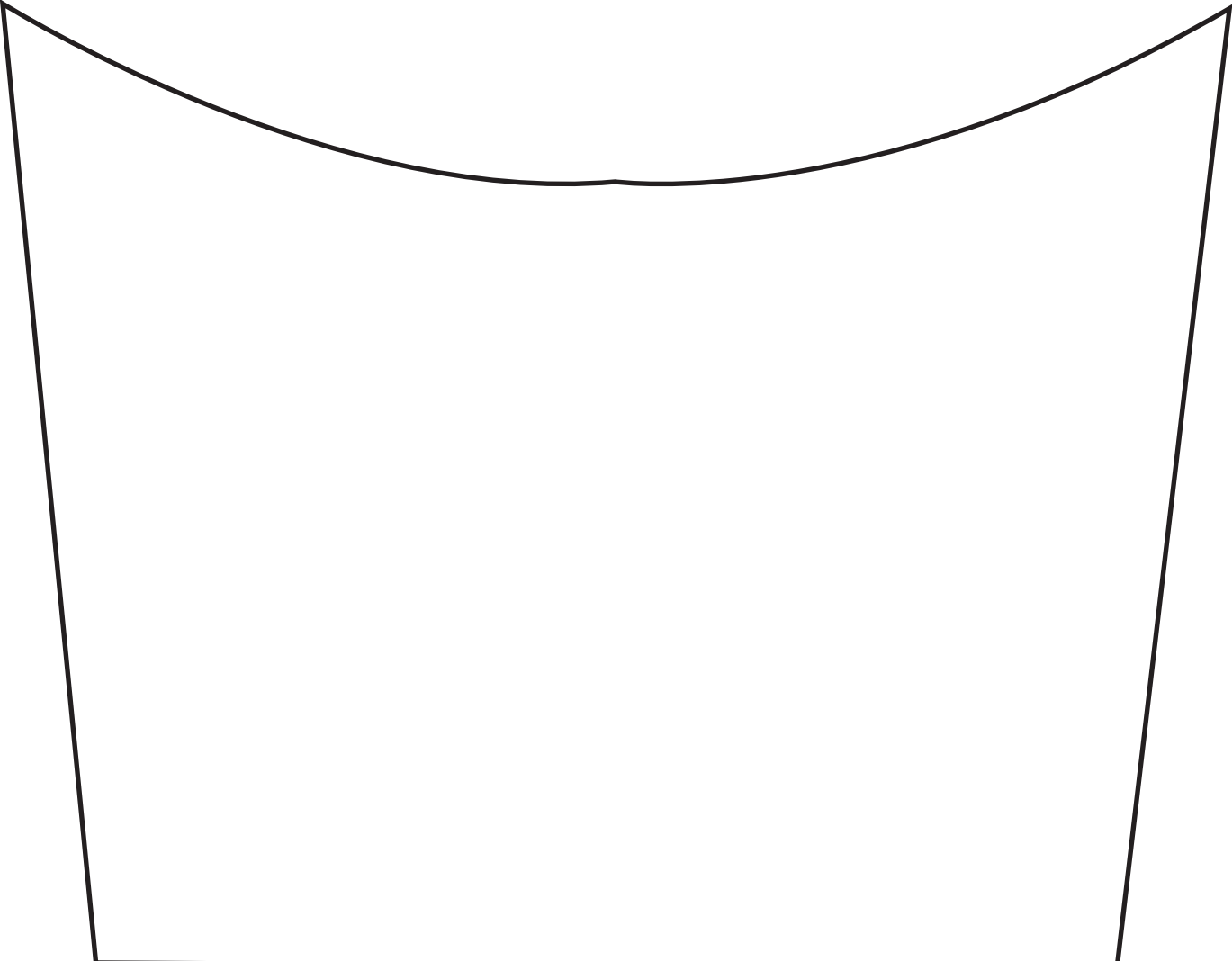
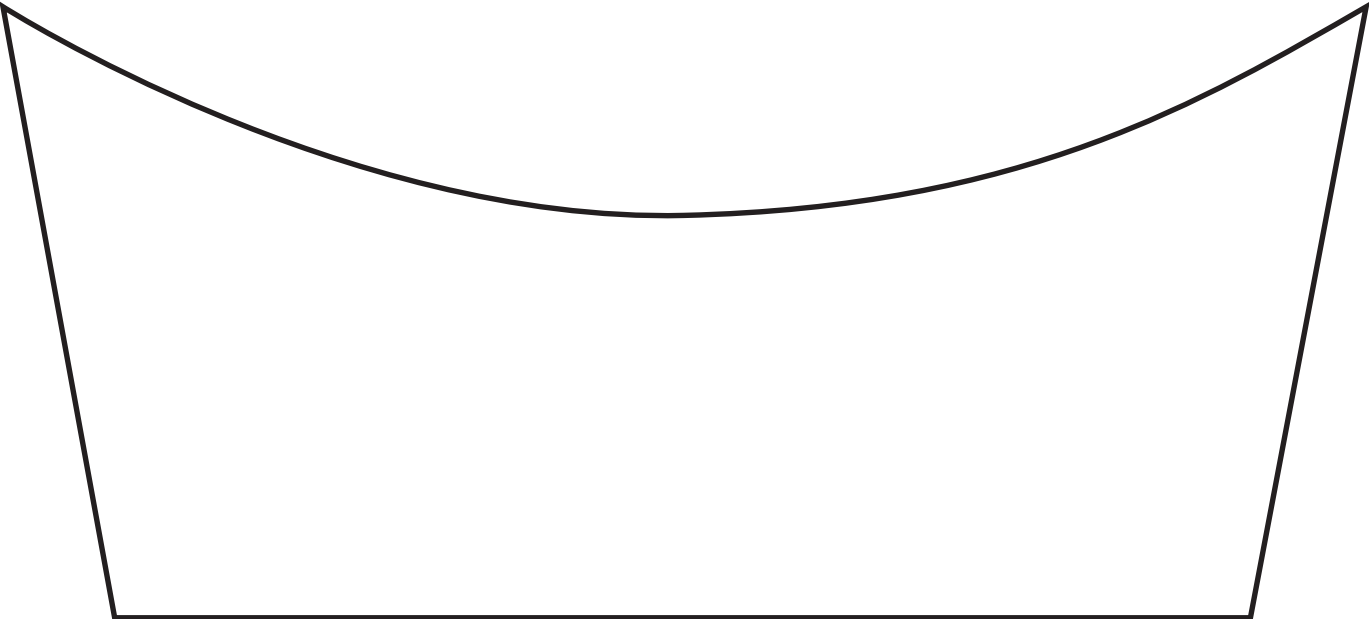

Cocktail Time

Have a girly night in with your friends thanks to this boozy set - the artwork is fab!

Page 44 in magazine

2 A4 pages

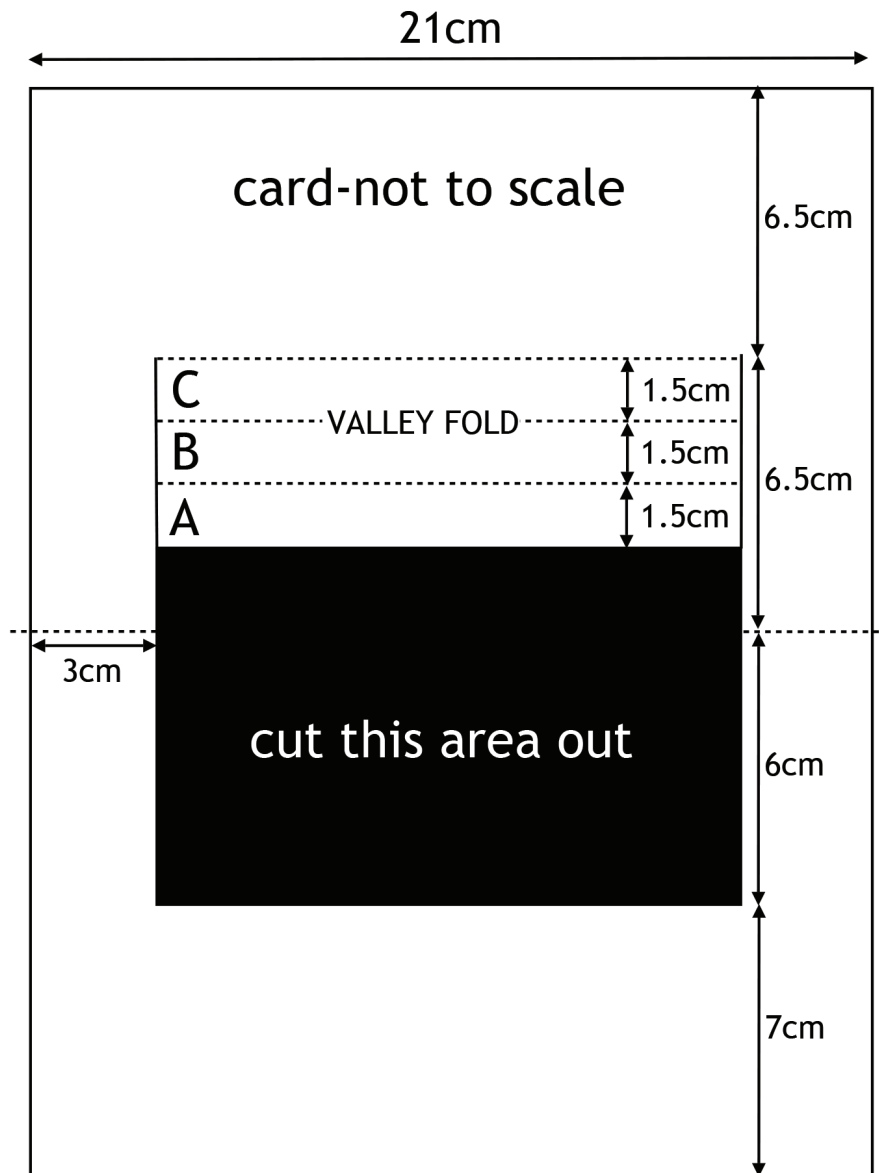

HAPPY BIRTHDAY

C H F E R S

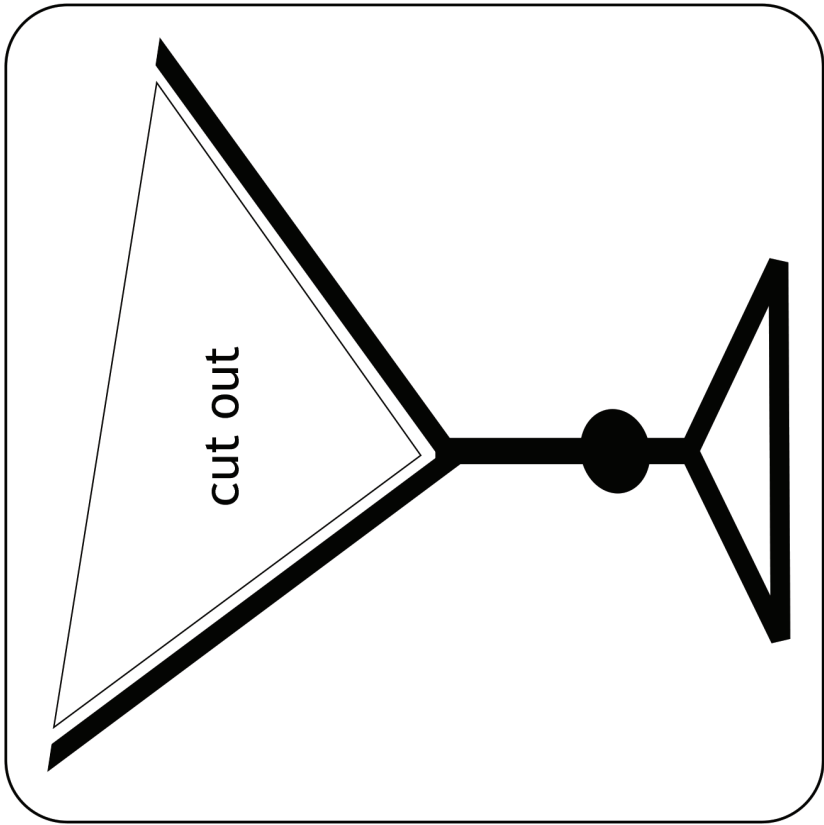

MOJITO

BLUE HAWAIIAN

PINA COLADA

20ml lime juice, mint leaves
50ml white rum, soda
2tsp brown sugar

10ml blue curacao, 40ml rum
20ml pineapple juice
20ml coconut milk
cherries

70ml pineapple juice
60ml coconut milk
30ml white rum